

The logo for Endüra Outdoor-Indoor Cabinetry is centered on a dark gray background. The word "Endüra" is written in a white, sans-serif font, with a white house icon integrated into the letter 'ü'. To the right of "Endüra" is a green circular icon containing a white leaf. Below the main logo, the text "Outdoor-Indoor Cabinetry" is written in a smaller, white, sans-serif font. The background features a large, faint, stylized leaf graphic in shades of gray and green, and a vertical green bar on the left edge.

Endüra
Outdoor-Indoor Cabinetry

PRODUCT CATALOG

TABLE OF CONTENTS

Welcome	1-2
Quality Standard Features	3-4
Texture, Colors & Profiles	5-6
Club	7-8
Regent	9-10
Sedona	11-12
Oxford	13-14
Moderno	15-16
Base Standard Specification Guide	17-19
Grill Base Specification Guide	20
Wall Cabinet Specifications Guide	21-23
Tall Cabinet Specification Guide	23
Accessory Specifications Guide	24-26
Bar-Back Guide	27-28
Fusion Cabinet Combinations	29-32
Information & General Care	33-34
Warranty & Claims	35-36
Customer Care	37-38



CABINETY AT ITS BEST

We invite you to experience "cabinety at its best," which means creating an all-around priceless business experience. We offer the perfect cabinet solution for a wide range of outdoor spaces. But we don't stop there. As a business partner, we strive to provide value, customer service, and efficient delivery to secure your decision to choose only Innovation Cabinetry for all your outdoor cabinetry needs.

OUR PROMISE



Quality you can afford



Ships in 7-10 days



Lifetime warranty



Made in Tampa, FL



Price & performance in perfect balance

2600+

Endura has more than 2600+ items in the Collection. The possibility offered by Innovation Cabinetry's Endura Collection makes living outdoors a unique experience by providing versatility, style, and durability all in one collection. Outdoor living opens up a whole new business experience for you, and a whole new living experience for your customers.

INNOVATION CABINETY

We are an American company headquartered in Tampa, Florida. We source and distribute high-quality cabinetry for designers, contractors, and builders. Our mission is to ensure our products are expertly crafted to last a lifetime.



STANDARD FEATURES

Precision routed door and drawer designs reflect today's most desirable looks in cabinetry.

Entire cabinet made of 0.75" all-weather high-density polyethylene (HDPE) for long-lasting beauty.

Matching interior and exterior finish for a flawless look.

Modern full-access box construction with full-depth adjustable shelving for an abundance of storage.



The maintenance-free, integrated poly-glide design allows for a smooth, easy glide-free drawer operation. OPTIONAL: Full extension, soft-close glides.

304 stainless steel 6-way adjustable hinges feature a soft-close mechanism for a whisper-soft close every time.

Factory machined, optional decorative end panel eliminates the expense of an overlay panel.

Constructed with a patented hidden joinery system for a beautiful exterior finish with no visible fasteners or screws.

High performance, heavy-duty adjustable legs with optional clip-on toe-kick.



With a recycle code 2, this product is easily recycled into usable products for home and garden



Discover the excellence of American-made outdoor cabinetry.



Ensure years of worry-free enjoyment



TEXTURES & COLORS

Matte and Decograin textures offer a soft-touch, with resistance to fingerprints and smudges.

FINISHES



Solid Matte



Decograin

SOLID MATTE



Heatherstone



Black Jack

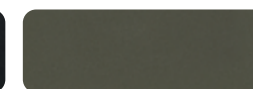

Mica

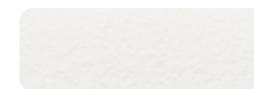

Dove

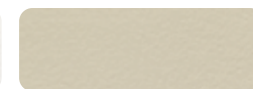

Dune



Symphony Blue

DECOGRAIN



White Oak



Barnwood Gray



Brown Walnut

Color accuracy is not exact on a digital print or computer screen. Request a sample before placing an order.

EDGE PROFILES

Endura door and drawer fronts come complete with complementing outside edge profiles. Each profile is carefully selected to harmonize with the door fronts creating a finished and sophisticated look.



Moderno



Regent



Sedona, Club, Oxford

GLIDE-STYLE

Endura cabinetry features two glide-style options, both ensure long-lasting use and reliability.

Maintenance-Free integrated glide built directly into the drawer wall. Soft-close full extension stainless steel glide.



SOFT-CLOSE SYSTEM
Stainless steel soft-close glides with full extension. Glides support up to 70lbs and have a two (2) year warranty. An additional charge applies



POLY-GLIDE SYSTEM
The integrated poly-glide design allows for smooth, easy drawer operation. This maintenance-free option comes with a lifetime warranty.

CLUB

- The Club profile is a perfect marriage of traditional and contemporary styling
- Fully constructed of 0.75" HDPE for long-lasting beauty
- Euro-style frameless cabinet for ample storage space
- Hidden joinery for a beautiful exterior finish with no visible fasteners
- Matching interior and exterior finish for a flawless look
- One-piece, full overlay door with precision horizontal grooves within a stylized flat border
- Door and drawer have a finished beveled outside edge for an elegant profile
- Soft-close door hinges feature a hydraulic mechanism to close in complete silence
- Optional decorative end and back panels match the door profile
- Offered in 6 solid matte and 3 wood grain finishes (page 6)

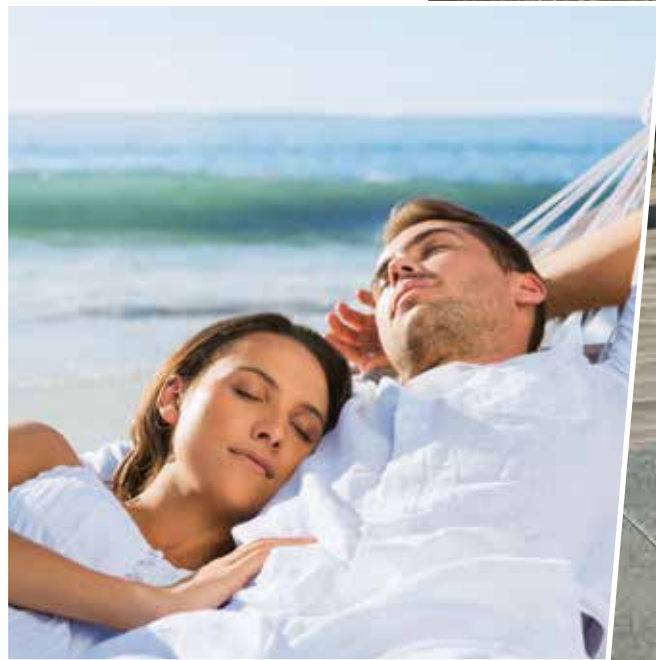

REGENT

- The Regent profile is a traditional style cabinet with plenty of classical charm
- Fully constructed of 0.75" HDPE for long-lasting beauty
- Euro-style frameless cabinet for ample storage space
- Hidden joinery for a beautiful exterior finish with no visible fasteners
- Matching interior and exterior finish for a flawless look
- One-piece, full overlay door with precision horizontal grooves within a stylized flat border
- Door and drawer have a finished ogee outside edge for an elegant profile
- Soft-close door hinges feature a hydraulic mechanism to close in complete silence
- Optional decorative end and back panels match the door profile
- Offered in 6 solid matte and 3 wood grain finishes (page 6)



SEDONA

- Sedona is a Shaker-style profile for a contemporary, minimalistic appearance
- Fully constructed of 0.75" HDPE for long-lasting beauty
- Euro-style frameless cabinet for ample storage space
- Hidden joinery for a beautiful exterior finish with no visible fasteners
- Matching interior and exterior finish for a flawless look
- One-piece, full overlay door with precision horizontal grooves within a stylized flat border
- Door and drawer have a finished beveled outside edge for an elegant profile
- Soft-close door hinges feature a hydraulic mechanism to close in complete silence
- Optional decorative end and back panels match the door profile
- Offered in 6 solid matte and 3 wood grain finishes (page 6)



OXFORD

- The Oxford profile resembles the popular V-grooved style for a farmhouse appearance
- Fully constructed of 0.75" HDPE for long-lasting beauty
- Euro-style frameless cabinet for ample storage space
- Hidden joinery for a beautiful exterior finish with no visible fasteners
- Matching interior and exterior finish for a flawless look
- One-piece, full overlay door with precision horizontal grooves within a stylized flat border
- Door and drawer have a finished beveled outside edge for an elegant profile
- Soft-close door hinges feature a hydraulic mechanism to close in complete silence
- Optional decorative end and back panels match the door profile
- Offered in 6 solid matte and 3 wood grain finishes (page 6)

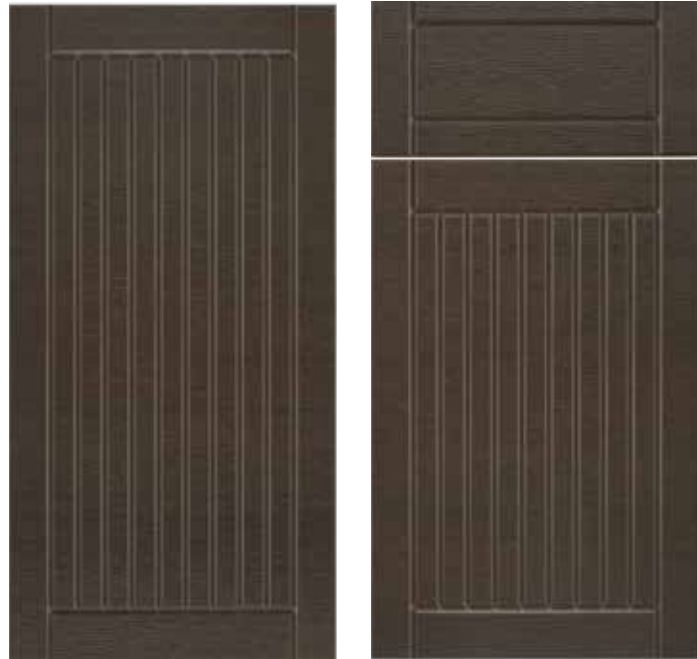

MODERNO

- The Moderno profile design is sleek, angular, and straightforward
- Fully constructed of 0.75" HDPE for long-lasting beauty
- Euro-style frameless cabinet for ample storage space
- Hidden joinery for a beautiful exterior finish with no visible fasteners
- Matching interior and exterior finish for a flawless look
- One-piece, full overlay door with precision horizontal grooves within a stylized flat border
- Door and drawer have a finished beveled outside edge for an elegant profile
- Soft-close door hinges feature a hydraulic mechanism to close in complete silence
- Optional decorative end and back panels match the door profile
- Offered in 6 solid matte and 3 wood grain finishes (page 6)

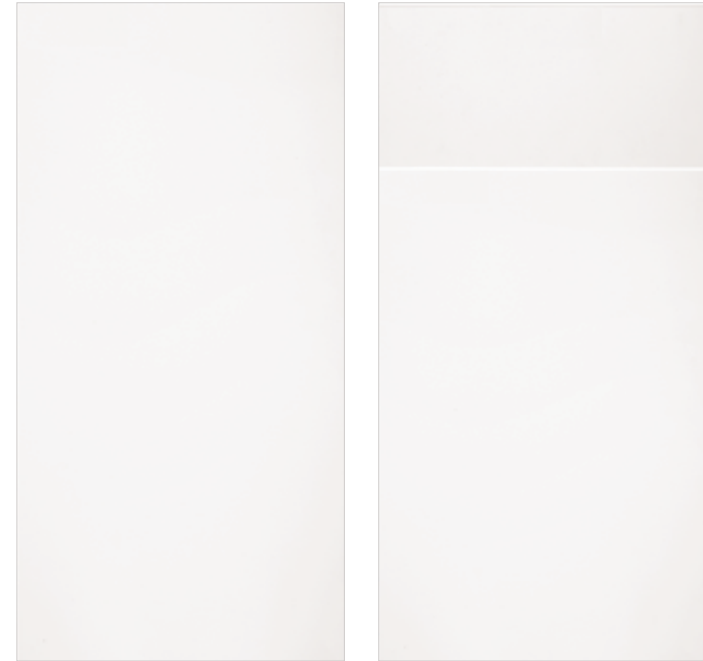

SPECIFICATIONS GUIDE BASE CABINETS

BASE FULL HEIGHT DOOR

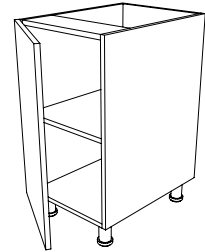

WIDTH	HEIGHT	DEPTH
12	34.5	24, 27, 30
15	34.5	24, 27, 30
18	34.5	24, 27, 30
21	34.5	24, 27, 30

AVAILABLE IN ALL STYLES AND COLORS
1 door.
Includes full-depth adjustable shelf.

BASE FULL HEIGHT DOORS

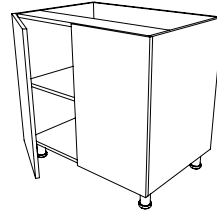

WIDTH	HEIGHT	DEPTH
24	34.5	24, 27, 30
27	34.5	24, 27, 30
30	34.5	24, 27, 30
33	34.5	24, 27, 30
36	34.5	24, 27, 30

AVAILABLE IN ALL STYLES AND COLORS
2 door.
Includes full-depth adjustable shelf.

BASE DOOR & DRAWER

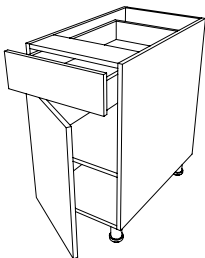

WIDTH	HEIGHT	DEPTH
12	34.5	24, 27, 30
15	34.5	24, 27, 30
18	34.5	24, 27, 30
21	34.5	24, 27, 30

AVAILABLE IN ALL STYLES AND COLORS
1 door, 1 upper drawer.
Includes full-depth adjustable shelf.

BASE DRAWER & DOOR

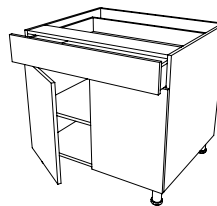

WIDTH	HEIGHT	DEPTH
24	34.5	24, 27, 30
27	34.5	24, 27, 30
30	34.5	24, 27, 30
33	34.5	24, 27, 30
36	34.5	24, 27, 30

AVAILABLE IN ALL STYLES AND COLORS
2 door, 1 upper drawer.
Includes full -depth adjustable shelf.

BASE MULTI-DRAWER

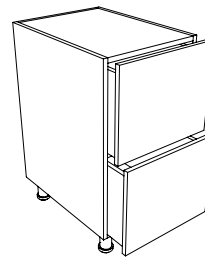

WIDTH	HEIGHT	DEPTH
12	34.5	24, 27, 30
15	34.5	24, 27, 30
18	34.5	24, 27, 30
21	34.5	24, 27, 30
24	34.5	24, 27, 30

AVAILABLE IN ALL STYLES AND COLORS
2 drawer.

BASE MULTI-DRAWER

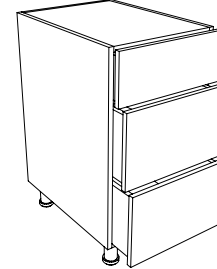

WIDTH	HEIGHT	DEPTH
12	34.5	24, 27, 30
15	34.5	24, 27, 30
18	34.5	24, 27, 30
21	34.5	24, 27, 30
24	34.5	24, 27, 30

AVAILABLE IN ALL STYLES AND COLORS
3 drawer.

SPECIFICATIONS GUIDE BASE CABINETS

BASE DIAGONAL CORNER

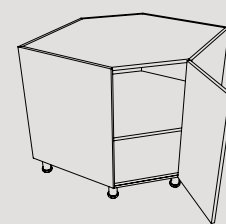

WIDTH	HEIGHT	DEPTH
36	34.5	24

AVAILABLE IN ALL STYLES AND COLORS
1 adjustable shelf.
Matches cabinets of 24" depth.

BASE BLIND CORNER

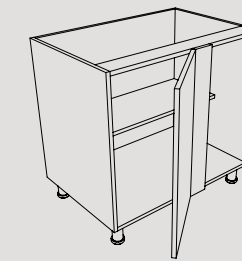

WIDTH	HEIGHT	DEPTH
39	34.5	24, 27, 30
42	34.5	24, 27, 30
45	34.5	24, 27, 30

AVAILABLE IN ALL STYLES AND COLORS
1 full-height door.
Includes one half depth adjustable shelf and one 6"x30" filler overlay.
Cabinet can be pulled for exact fit.

BASE BLIND CORNER

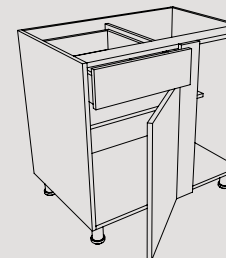

WIDTH	HEIGHT	DEPTH
39	34.5	24, 27, 30
42	34.5	24, 27, 30
45	34.5	24, 27, 30

AVAILABLE IN ALL STYLES AND COLORS
1 door, 1 drawer.
Includes one half depth adjustable shelf and one 6"x30" filler overlay.
Cabinet can be pulled for exact fit.

SINK BASE DOOR WITH FALSE FRONT

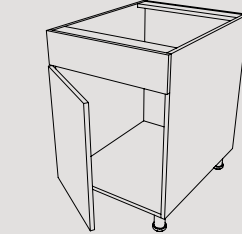

WIDTH	HEIGHT	DEPTH
15	34.5	24, 27, 30
18	34.5	24, 27, 30
21	34.5	24, 27, 30

AVAILABLE IN ALL STYLES AND COLORS
1 door with false drawer front.

SINK BASE DOOR WITH FALSE FRONT

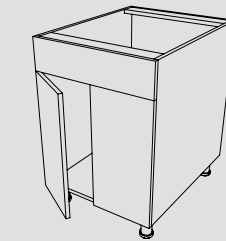

WIDTH	HEIGHT	DEPTH
24	34.5	24, 27, 30
27	34.5	24, 27, 30
30	34.5	24, 27, 30
33	34.5	24, 27, 30
36	34.5	24, 27, 30

AVAILABLE IN ALL STYLES AND COLORS
2 door with false drawer front.

SINK BASE FULL HEIGHT DOOR

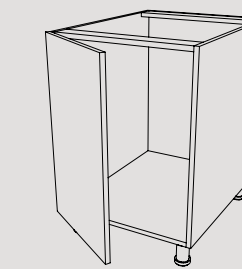

WIDTH	HEIGHT	DEPTH
15	34.5	24, 27, 30
18	34.5	24, 27, 30
21	34.5	24, 27, 30

AVAILABLE IN ALL STYLES AND COLORS
1 full-height door.

SPECIFICATIONS GUIDE BASE CABINETS

SINK BASE 2 FULL DOORS

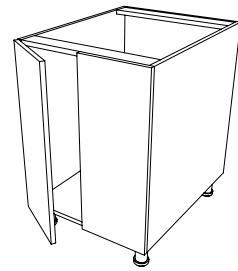

WIDTH	HEIGHT	DEPTH
27	34.5	24, 27, 30
30	34.5	24, 27, 30
36	34.5	24, 27, 30

AVAILABLE IN ALL STYLES AND COLORS
2 full-height doors.

SINK BASE FARMHOUSE

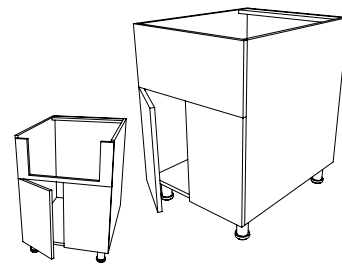

WIDTH	HEIGHT	DEPTH
30	34.5	24, 27, 30
33	34.5	24, 27, 30
36	34.5	24, 27, 30

AVAILABLE IN ALL STYLES AND COLORS
2 door farmhouse or apron-front.
Includes removable faceplate with 4-quick release clips for easy in-field modifications.

SINK BASE 1 DOOR, BOTTOM DRAWER

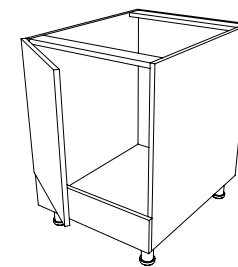

WIDTH	HEIGHT	DEPTH
15	34.5	24, 27, 30
18	34.5	24, 27, 30
21	34.5	24, 27, 30

AVAILABLE IN ALL STYLES AND COLORS
1 door and 1 drawer at base.

SINK BASE 2 DOOR, BOTTOM DRAWER

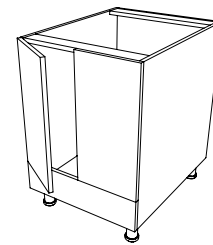

WIDTH	HEIGHT	DEPTH
24	34.5	24, 27, 30
27	34.5	24, 27, 30
30	34.5	24, 27, 30
33	34.5	24, 27, 30
36	34.5	24, 27, 30

AVAILABLE IN ALL STYLES AND COLORS
2 door and 1 drawer at base.

BASE WASTEBASKET 1 DOOR

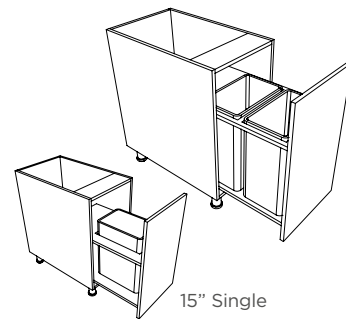

WIDTH	HEIGHT	DEPTH
15	34.5	24, 27, 30
18	34.5	24, 27, 30
21	34.5	24, 27, 30

AVAILABLE IN ALL STYLES AND COLORS
1 pullout, full-height door.
15" includes 1 wastebasket.
18" & 21" includes 2 wastebaskets

15" Single

WASTEBASKET 1 DOOR, 1 DRAWER

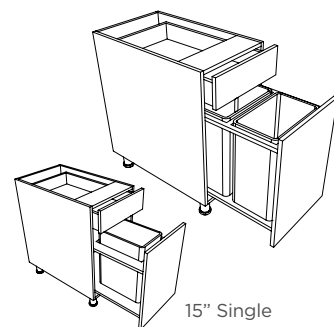

WIDTH	HEIGHT	DEPTH
15	34.5	24, 27, 30
18	34.5	24, 27, 30
21	34.5	24, 27, 30

AVAILABLE IN ALL STYLES AND COLORS
1 Door and 1 drawer.
15" includes 1 wastebasket.
18" & 21" includes 2 wastebaskets

15" Single

SPECIFICATIONS GUIDE BASE CABINETS

GRILL BASE 1 DOOR*

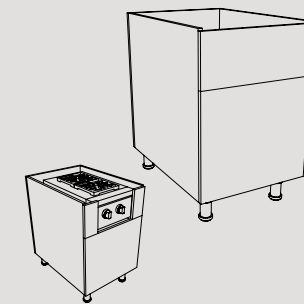

WIDTH	HEIGHT	DEPTH
15	34.5	27, 30
18	34.5	27, 30
21	34.5	27, 30

AVAILABLE IN ALL STYLES AND COLORS
Grill base or side burner, 1 door.
Includes removable faceplate with quick release clips for easy in-field modifications.

GRILL BASE 2 DOOR*

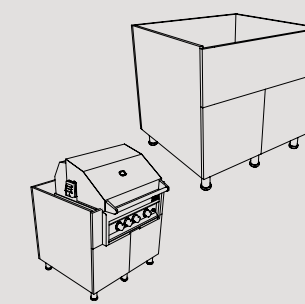

WIDTH	HEIGHT	DEPTH
24	34.5	27, 30
27	34.5	27, 30
30	34.5	27, 30
33	34.5	27, 30
36	34.5	27, 30
39	34.5	27, 30
42	34.5	27, 30

AVAILABLE IN ALL STYLES AND COLORS
Grill base or side burner, 2 door.
Includes removable faceplate with quick release clips for easy in-field modifications.

GRILL BASE 4 DOOR*

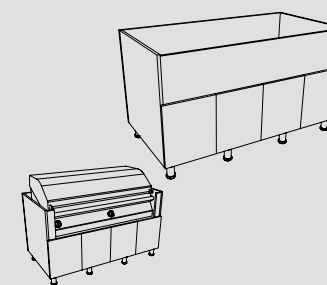

WIDTH	HEIGHT	DEPTH
45	34.5	27, 30
48	34.5	27, 30
51	34.5	27, 30
54	34.5	27, 30
57	34.5	27, 30
60	34.5	27, 30
63	34.5	27, 30

AVAILABLE IN ALL STYLES AND COLORS
4 door, grill base cabinet.

GRILL BASE EGG 1 DOOR

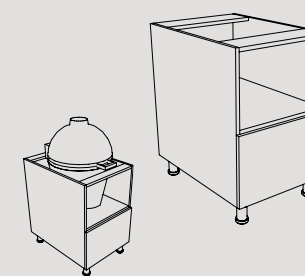

WIDTH	HEIGHT	DEPTH
21	34.5	27, 30
21	34.5	27, 30

AVAILABLE IN ALL STYLES AND COLORS
1 door, Egg/Kamado grill base cabinet.

GRILL BASE EGG 2 DOOR

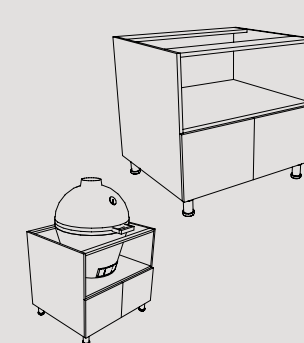

WIDTH	HEIGHT	DEPTH
24	34.5	27, 30
27	34.5	27, 30
30	34.5	27, 30
33	34.5	27, 30
36	34.5	27, 30

AVAILABLE IN ALL STYLES AND COLORS
2 door, Egg/Kamado grill base cabinet.

GRILL BASE EGG 1 DRAWER

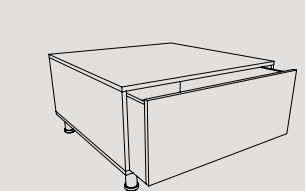

WIDTH	HEIGHT	DEPTH
36	19.5	36

AVAILABLE IN ALL STYLES AND COLORS
1 drawer, Egg/Kamado grill base cabinet.

***WARNING:** All grills and side burners must be installed using an insulated liner to prevent damaging cabinets.

SPECIFICATIONS GUIDE WALL CABINETS

WALL CABINET 1 DOOR

WIDTH	HEIGHT	DEPTH
21	15	12

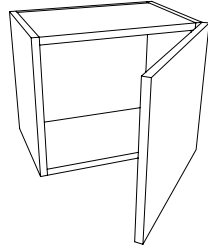

AVAILABLE IN ALL STYLES AND COLORS
1 door, no shelf.

WALL CABINET 1 DOOR

WIDTH	HEIGHT	DEPTH
21	24	12

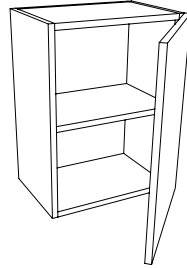

AVAILABLE IN ALL STYLES AND COLORS
1 door, 1 shelf.
Includes 1 full-depth shelf.

WALL CABINET 1 DOOR

WIDTH	HEIGHT	DEPTH
12	30	12
15	30	12
18	30	12
21	30	12

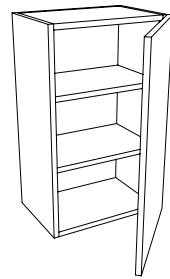

AVAILABLE IN ALL STYLES AND COLORS
1 door.
Includes 2 full-depth adjustable shelves.

WALL CABINET 2 DOOR

WIDTH	HEIGHT	DEPTH
24	15	12
27	15	12
30	15	12
36	15	12

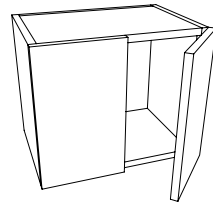

AVAILABLE IN ALL STYLES AND COLORS
2 door, no shelf.

WALL CABINET 2 DOOR

WIDTH	HEIGHT	DEPTH
24	24	12
27	24	12
30	24	12
36	24	12

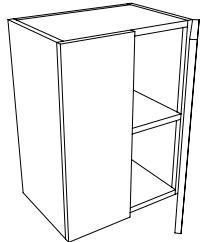

AVAILABLE IN ALL STYLES AND COLORS
2 door.
Includes 1 full-depth shelf.

WALL CABINET 2 DOOR

WIDTH	HEIGHT	DEPTH
24	30	12
27	30	12
30	30	12
33	30	12
36	30	12



AVAILABLE IN ALL STYLES AND COLORS
2 door.
Includes 2 full-depth shelves.

SPECIFICATIONS GUIDE WALL CABINETS

WALL CABINET NO DOOR

WIDTH	HEIGHT	DEPTH
21	15	12
24	15	12
27	15	12
30	15	12
36	15	12

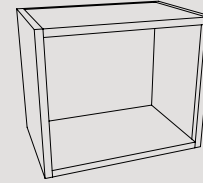

AVAILABLE IN ALL STYLES AND COLORS
No door, no shelf.

WALL CABINET NO DOOR

WIDTH	HEIGHT	DEPTH
21	24	12
24	24	12
27	24	12
30	24	12
36	24	12

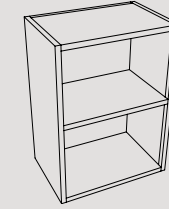

AVAILABLE IN ALL STYLES AND COLORS
No door.
Includes 1 full-depth shelf.

WALL CABINET NO DOOR

WIDTH	HEIGHT	DEPTH
12	30	21
18	30	21
21	30	21
24	30	21
27	30	21
30	30	21
33	30	21
36	30	21

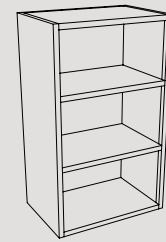

AVAILABLE IN ALL STYLES AND COLORS
No door.
Includes 2 full-depth adjustable shelves

WALL CABINET 24 DEEP 1 DOOR

WIDTH	HEIGHT	DEPTH
21	15, 24	24

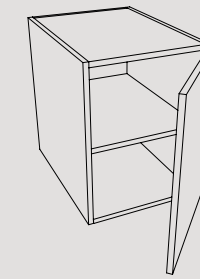

AVAILABLE IN ALL STYLES AND COLORS
1 door.
15" includes no shelf.
24" includes 2 full-depth shelves.

WALL CABINET 24 DEEP 2 DOOR

WIDTH	HEIGHT	DEPTH
24	15, 24	24
27	15, 24	24
30	15, 24	24
36	15, 24	24

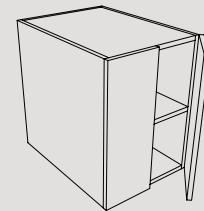

AVAILABLE IN ALL STYLES AND COLORS
2 door.
15" Cabinet, no shelf
24" Cabinet 1 full-depth adjustable shelf

WALL CABINET 24 DEEP NO DOOR

WIDTH	HEIGHT	DEPTH
21	15, 24	24
24	15, 24	24
27	15, 24	24
30	15, 24	24
36	15, 24	24

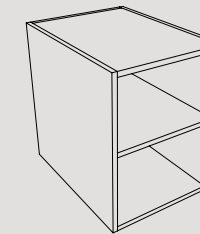

AVAILABLE IN ALL STYLES AND COLORS
No door.
15" includes no shelf.
24" includes 1 full-depth shelf.

SPECIFICATIONS GUIDE WALL & STORAGE CABINETS

WALL DIAGONAL CORNER

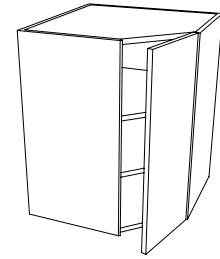

WIDTH HEIGHT DEPTH

24 30 12

AVAILABLE IN ALL STYLES AND COLORS
1 full-height door.
Includes 2 full-depth adjustable shelves.

STORAGE CABINET 2 DOOR

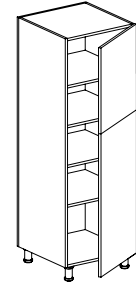

WIDTH HEIGHT DEPTH

15, 18 84, 90, 96 24

AVAILABLE IN ALL STYLES AND COLORS
2 doors: 1 upper, 1 lower.
Includes 4 adjustable shelves.
One fixed shelf dividing upper and lower doors.

STORAGE CABINET 4 DOOR

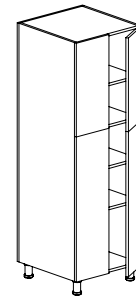

WIDTH HEIGHT DEPTH

24 84, 90, 96 24

AVAILABLE IN ALL STYLES AND COLORS
4 doors: 2 upper, 2 lower
Includes 1 fixed and 3 adjustable shelves.
One fixed shelf dividing upper and lower doors.

SPECIFICATIONS GUIDE ACCESSORY

TOE-KICK

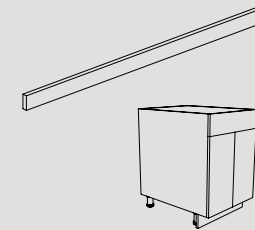

WIDTH HEIGHT DEPTH

48 4.5, 8 0.75
96 4.5, 8 0.75

AVAILABLE IN ALL STYLES AND COLORS
Toe-kick can be modified in the field.
Does not include clips.

DECORATIVE SHELF

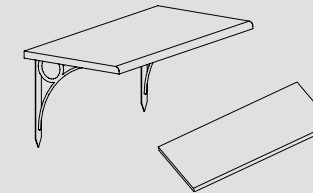

WIDTH HEIGHT DEPTH

24 0.75 12
36 0.75 12
48 0.75 12
60 0.75 12

AVAILABLE IN ALL STYLES AND COLORS
Has one rounded edge.
Support hardware not included.

BAR-BACK BASE RETURN

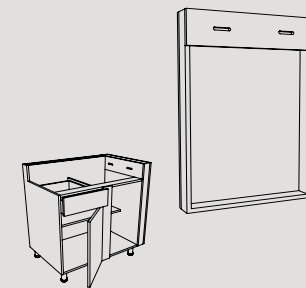

WIDTH HEIGHT DEPTH

15 36 3
21 36 3
24 36 3
27 36 3
30 36 3
33 36 3
36 36 3

AVAILABLE IN ALL STYLES AND COLORS
Required use with bar-back blind base.

LEG ASSEMBLY KIT

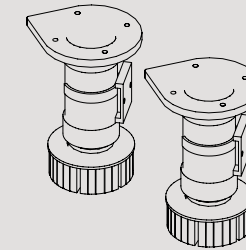

WIDTH HEIGHT

2 3.75

ADJUSTABLE HEIGHT
Constructed of hard plastic for anti-rust, anti-corrosion, sturdy and durable, great for long-term outdoor use.
Kit includes: 2 leg assemblies, toe-kick clips and screws.
Full extension: 5-8.75"

FILLER



WIDTH HEIGHT DEPTH

3, 6 30 0.75
3, 6 36 0.75
3, 6 42 0.75

AVAILABLE IN ALL STYLES AND COLORS
Filler may be cut to size in the field.

FINISHED PANEL



WIDTH HEIGHT DEPTH

12, 24 15 0.75
12, 24 24 0.75
12, 24 30 0.75

AVAILABLE IN ALL STYLES AND COLORS
Cut to size in the field.

SPECIFICATIONS GUIDE ACCESSORY

FINISHED PANEL

WIDTH	HEIGHT	DEPTH
96	42	0.75

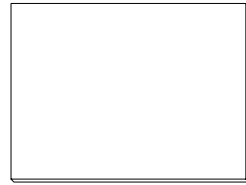

AVAILABLE IN ALL STYLES AND COLORS
Cut to size in the field.

FINISHED PANEL WITH 3" REVEAL

WIDTH	HEIGHT	DEPTH
3	34.5	24
3	34.5	27
3	34.5	30

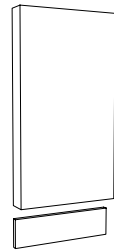

AVAILABLE IN ALL STYLES AND COLORS
Invert for left or right installation.
Includes trimmable toe-kick and hardware.

FINISHED PANEL WITH 6" REVEAL

WIDTH	HEIGHT	DEPTH
6	34.5	24
6	34.5	27
6	34.5	30

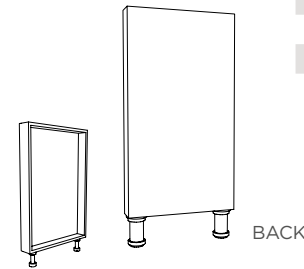

AVAILABLE IN ALL STYLES AND COLORS
Invert for left or right installation.
Includes 1 Leg Assembly Kit.

DECOR END PANEL

WIDTH	HEIGHT	DEPTH
0.75	15	12, 24
0.75	24	12, 24
0.75	30	12, 24

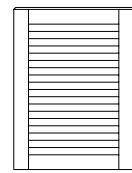

AVAILABLE IN ALL STYLES AND COLORS
Decor end panels are designed to match the door profiles for standalone or island installation.

DECOR END PANEL WITH 3" REVEAL

WIDTH	HEIGHT	DEPTH
3	34.5	24
3	34.5	27
3	34.5	30

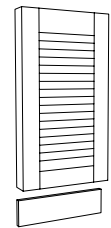

AVAILABLE IN ALL STYLES AND COLORS
Invert for left or right installation.
Includes trimmable toe-kick and hardware.

DECOR PANEL WITH 6" REVEAL

WIDTH	HEIGHT	DEPTH
6	34.5	24, 27, 30

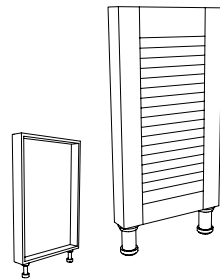

AVAILABLE IN ALL STYLES AND COLORS
Invert for left or right installation.
Includes 1 Leg Assembly Kit.
Designed to match the door profile for standalone or island installation.

SPECIFICATIONS GUIDE ACCESSORY DECOR END PANELS

PANEL 15" TALL

WIDTH	HEIGHT	DEPTH
21	15	0.75
24	15	0.75
27	15	0.75
30	15	0.75
36	15	0.75

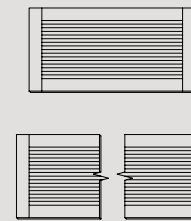

AVAILABLE IN ALL STYLES AND COLORS
Decor end panels are designed to match the door profiles for standalone or island installation.

PANEL 24" TALL

WIDTH	HEIGHT	DEPTH
21	24	0.75
24	24	0.75
27	24	0.75
30	24	0.75
36	24	0.75

AVAILABLE IN ALL STYLES AND COLORS
Decor end panels are designed to match the door profiles for standalone or island installation.

PANEL 30" TALL

WIDTH	HEIGHT	DEPTH
2	30	0.75
15	30	0.75
18	30	0.75
21	30	0.75
24	30	0.75
27	30	0.75
30	30	0.75
33	30	0.75
36	30	0.75
39	30	0.75
42	30	0.75
45	30	0.75
48	30	0.75
51	30	0.75
54	30	0.75
57	30	0.75
60	30	0.75
63	30	0.75
72	30	0.75
96	30	0.75

AVAILABLE IN ALL STYLES AND COLORS
Decor end panels are designed to match the door profiles for standalone or island installation.

PANEL 36" TALL

WIDTH	HEIGHT	DEPTH
12	36	0.75
15	36	0.75
18	36	0.75
21	36	0.75
24	36	0.75
27	36	0.75
30	36	0.75
33	36	0.75
36	36	0.75
39	36	0.75
42	36	0.75
45	36	0.75
48	36	0.75
72	36	0.75
96	36	0.75

AVAILABLE IN ALL STYLES AND COLORS
Decor end panels are designed to match the door profiles for standalone or island installation.



BAR-BACKS



Endura bar-back cabinetry is designed with a raised 6" high backsplash. This raised cabinet back allows the cantilevering of countertop material to create a bar-height counter. A bar-back cabinet can help create a definition between the kitchen and the rest of the outdoor living area.

Endura bar-backs are seamlessly built into the side of the cabinet base. This unique build provides cabinet strength and durability with a flawless finish.

BAR-BACKS ARE AVAILABLE IN THE FOLLOWING CABINETS
All Base Cabinets | Sink Bases | Multi Drawer Cabinets | Wastebaskets | All Grill Bases

Bar-back cabinets have optional Décor End and Back panels to match the door profile for standalone or island installation. Décor End and Back panels compliment the door profile and are factory installed.

To order, choose SKUs with DL (Décor Left), DR (Décor Right), or B (Decor Both Ends) in the SKU nomenclature.

Décor End Back panels are an accessory purchased separately and installed in the field.



Reference the Endura Specification Book for detailed information.

SPECIFICATIONS GUIDE ENDURA FUSIONS

Endura Outdoor Fusions are cabinet combinations grouped to create beautiful, functional layouts. Create your own perfect combination or borrow one of these, and start living outdoors! Combinations do not include, counter tops, grills or appliances. 🚚 All Endura combinations ship in 7-10 days after order is placed.



ADAGIO

WIDTH	96	AVAILABLE IN ALL STYLES AND COLORS	
HEIGHT	34.5	(1) EN-B36-27-DL	ISLAND OPTION
DEPTH	27	(1) EN-BG42-27	(1) EN-DEB9630
		(1) EN-BWB18-27-PF-DR	(1) EN-TK96
		(1) EN-TK-96	
		(1) EN-TK-48	



GRILL KING

WIDTH	126	AVAILABLE IN ALL STYLES AND COLORS	
HEIGHT	34.5	To be used with stand alone grill.	
DEPTH	27	Cabinets flank both sides of the grill.	
		(1) EN-B24-27	
		(1) EN-BWB21-27-PS	
		FREESTANDING 36" GRILL	
		(1) EN-B24-27	
		(1) EN-DB21-3-27	
		(2) EN-TK96	
		(1) EN-TK48	



FREMONT

WIDTH	72	AVAILABLE IN ALL STYLES AND COLORS	
HEIGHT	34.5	(1) EN-BWB15-27-PF-DL	ISLAND OPTION
DEPTH	27	(1) EN-BG42-27	(1) EN-DEB7230
		(1) EN-DB15-3-27-DR	(1) EN-TK96
		(1) EN-TK48	
		(1) EN-TK96	

SPECIFICATIONS GUIDE ENDURA FUSIONS



PARKWAY

LEFT WIDTH	96	AVAILABLE IN ALL STYLES AND COLORS	
HEIGHT	34.5	SHOWN AS RIGHT SIDE PENINSULA	
RIGHT WIDTH	96	(1) EN-SB30-27	(1) EN-B12-27-L
		(1) EN-BWB21-27-PF	(1) EN-BG42-27
		(1) EN-BBC45-27-RF	(1) EN-DB15-2-27
			(2) EN-F330
			(4) EN-TK96
			(1) EN-DEB9630



UPTOWNER

WIDTH	60	AVAILABLE IN ALL STYLES AND COLORS	
HEIGHT	34.5	(1) EN-BWB18-PF	ISLAND OPTION
DEPTH	27	(1) EN-BG42-27	(1) EN-DEB6030
		(1) EN-TK96	(1) EN-TK96
		(1) EN-TK48	



TROPICALE

WIDTH	96	AVAILABLE IN ALL STYLES AND COLORS	
HEIGHT	34.5	(1) EN-B21-27-L	ISLAND OPTION
DEPTH	27	(1) EN-B18-27-L	(1) EN-DEB9630
		(1) EN-BG36-27	(1) EN-TK96
		(1) EN-BWB21-27-PS	
		(2) EN-TK96	

SPECIFICATIONS GUIDE ENDURA FUSIONS



SOMMERSET

WIDTH	66	AVAILABLE IN ALL STYLES AND COLORS	
HEIGHT	34.5		
DEPTH	27	(1) EN-BG15-27-L	ISLAND OPTION
		(1) EN-BG36-27	(2) EN-DEB3330
		(1) EN-BWB15-27-PS	(1) EN-TK96
		(1) EN-TK48	
		(1) EN-TK96	



BUNGALOW

WIDTH	96	AVAILABLE IN ALL STYLES AND COLORS	
HEIGHT	34.5		
DEPTH	27	(1) EN-BG21-27-L	ISLAND OPTION
		(1) EN-B18-27-L	(1) EN-DEB9630
		(1) EN-BG36-27	(1) EN-TK96
		(1) EN-BWB21-27-PS	
		(1) EN-TK96	
		(1) EN-TK48	



BERMUDA

WIDTH	72	AVAILABLE IN ALL STYLES AND COLORS	
HEIGHT	34.5		
DEPTH	27	(1) EN-B18-27-L	ISLAND OPTION
		(1) EN-BG36-27	(1) EN-DEB7230
		(1) EN-B18-27-R	(1) EN-TK96
		(1) EN-TK96	
		(1) EN-TK48	

SPECIFICATIONS GUIDE ENDURA FUSIONS



ADVENTURER

WIDTH	72	AVAILABLE IN ALL STYLES AND COLORS	
HEIGHT	34.5		
DEPTH	27	(1) EN-BG18-27-L-DL	ISLAND OPTION
		(1) EN-BG36-27	(1) EN-DEB7230
		(1) EN-B18-27-RF-DL	(1) EN-TK96
		(1) EN-TK96	
		(1) EN-TK48	



BOUNTY

WIDTH	66	AVAILABLE IN ALL STYLES AND COLORS	
HEIGHT	34.5	To be used with stand alone grill. Cabinets flank both sides of the grill.	
DEPTH	27	(1) EN-BG15-27-L	ISLAND OPTION
		(1) EN-BG36-27	(2) EN-DEB3330
		(1) EN-B15-27-R	(1) EN-TK96
		(1) EN-TK96	
		(1) EN-TK48	



THE CLASSIC

LEFT WIDTH	66	AVAILABLE IN ALL STYLES AND COLORS	
HEIGHT	34.5	SHOWN AS A LEFT SIDE PENINSULA	
RIGHT WIDTH	96	(1) EN-DB15-3-27	(1) EN-F330
		(1) EN-SB24-27	(2) EN-DEB3330
		(1) EN-F330-27	(1) EN-TK-96
		(1) EN-BBC39-27-L	
		(1) EN-BG45-27	
		(1) EN-B12-27-R	
		(2) EN-TK-96	

INFORMATION

MAXIMUM RESILIENCY MEANS MINIMAL MAINTENANCE

Endura cabinetry is built to be UV and weather resistant. Crafted from high-density polyethylene (HDPE), Endura is built to withstand rigorous daily outdoor and indoor use. To keep Endura cabinetry looking good, follow these simple cleaning instructions.

GENERAL CARE CARE

- Clean regularly with a standard soap and water solution and a soft cotton cloth.
- Acceptable cleaners: 10% chlorine bleach dilution, hand washing liquid soap, glass cleaner, ammonia, furniture polish.
- If debris or grease appears on the surface, spray the affected area with a garden hose. If necessary, remove excess dirt and debris by scrubbing with a soft bristle brush or sponge.
- Allow the material to air dry or use a soft towel to remove excess moisture.
- A pressure washer with no greater than 1500 PSI may be used to remove dirt, dust, or other types of airborne particulates. Use a wide angled (40° >) spray nozzle and do not direct the sprayer less than 8" from the cabinetry surface.

AVOID THE FOLLOWING CLEANING PRODUCTS

- Chemical cleaners, sprays, and hard scrubbers.
- Spic & Span which contains abrasives Sodium Carbonate and Sodium Silicate.
- Tilex which contains Sodium Hypochlorite.
- Comet which contains abrasives Calcium Carbonate and Sodium Carbonate.

HARDWARE CLEANING CARE

Decorative surface hardware such as drawer and door pulls, and knobs should be stainless steel, with stainless steel screws for best results. Refer to the hardware manufacturer's recommendations for the cleaning of stainless steel hardware.

Hinges and optional soft-close glides require little to no maintenance. Should dust or debris appear on the surface of a hinge or glide, remove using a soft bristle brush or toothbrush.

Apply spray lubricant such as WD-40 to the hinge. Then open and close the cabinet door a few times so the lubricant can work into the hinge while its parts are in motion.

CAUTION: Storing open containers of caustic chemicals inside the cabinets can be corrosive to the hinges.

7-10 DAY DELIVERY

Quicker turn around time equal faster revenue influx. Innovation Cabinetry is committed to providing a 7-10 Day Delivery Guarantee for most orders upon order confirmation and payment. Fast delivery allows you to keep revenue flowing and show your customers you are committed to their projects.

ASSEMBLY

Endura products are fully assembled for efficient transport and the preservation of goods during transportation. As made-to-order cabinetry, there are no refunds or returns on Endura products. Your Innovation Sales Account Manager can provide ordering and design assistance to ensure order accuracy.

EASY INSTALLATION

Your Endura outdoor kitchen arrives fully assembled. Installation is straightforward using standard hand tools. Some installations can be installed in as little as one day.



RECYCLE | REUSE | REPURPOSE

Innovation Cabinetry is working hand in hand with our HDPE supplier to ensure we manufacture our products responsibly. Through the TAKE-BACK Program, we can recycle 90% of our refuse from the manufacturing process into usable post-industrial products.

Creating a recycling program with our supplier enables us to reduce the burden on landfills while minimizing our demand for new raw materials.

Once the HDPE scraps from the manufacturing process are collected, they are returned to the supplier and entered into their recycling process. Once processed, the material is sold to third parties or reused by other manufacturers.



WARRANTY

ENDURA CABINETS LIFETIME LIMITED WARRANTY

Thank you for purchasing Innovation Cabinetry, LLC's high-quality cabinetry products! We trust that our products will bring you many years of outstanding service and appearance.

Innovation Cabinetry, LLC warrants that Endura cabinetry products shall be free from defects in material and workmanship under the following conditions:

This Warranty applies only to first quality High-Density Polyethylene (HDPE) cabinet carcasses, doors, drawers, and shelves manufactured by Simmetry Manufacturing, LLC, for Innovation Cabinetry, LLC, purchased from an authorized retailer. It is only applicable to properly installed products used in residential applications within the United States by the original purchaser, and it is not transferable. Hinges and leveling legs are provided with a five (5) year limited warranty. Optional factory-installed metal drawer glides have a two (2) year limited warranty. Both warranties are subject to the same conditions, exclusions, and limitations detailed herein.

This Warranty does not cover normal wear and tear, accidents, spills, improper cleaning, misuse, improper installation, abuse, accidents, negligence, alterations, unauthorized repairs, commercial use, exposure or contact with caustic chemicals, and any other cause of damage unrelated to a defect in workmanship or material. In addition, environmental conditions, lighting, and surrounding colors can affect the perception of the colored finish and sunlight and other conditions can cause natural aging of the finish. These are not defects covered by this Warranty.

Under the terms of this Warranty, Innovation Cabinetry, LLC, in its sole discretion, will determine the appropriate remedy and will either repair or replace the defective item or parts. Refunds are generally not available. Innovation Cabinetry, LLC cannot guarantee that these replacements will match the residential application's original components' colors, hues, sheens, textures, finish, or appearance.

The repair or replacement of an item or part does not extend the duration of the warranty period or start a new warranty period. In-home inspection fees, transportation of the product to and from the retail store, and to and from Innovation Cabinetry, LLC, if required for repairs are the responsibility of the purchaser.

HDPE is a manufactured product sourced by Simmetry Manufacturing, LLC. Colors are subject to availability and may be changed or discontinued over time. Innovation Cabinetry, LLC reserves the right to alter design, specifications, and material without obligation to make similar changes to products previously manufactured.

If a warranty claim is filed after a product or color is discontinued, Innovation Cabinetry, LLC reserves the right to honor the Warranty in one of the following fashions:

- To replace the affected component with a new component of the same style.

- To replace the affected component and any other component(s) in the residential application to achieve a reasonably uniform appearance with a similar and comparable product style to the initially purchased style.
- Refund the purchase price of the defective component.

This Warranty is provided only under the following conditions:

Proper safeguards are incorporated in the use and care of cabinets in accordance with local building codes and Innovation Cabinetry's Installation Guide and Cabinet Cleaning and Care Guidelines including:

1. Proper installation
2. Protection against contact with extreme heat and harmful substances.
3. Adherence to appliance manufacturers' specifications for installation and ventilation of cabinets.

This Warranty shall become void if the cabinets are in any way modified, improperly installed, or damaged before or during the installation process.

THE LIMITED WARRANTY IS THE EXCLUSIVE WARRANTY OF INNOVATION CABINETRY, LLC. THIS LIMITED WARRANTY IS EXTENDED IN LIEU OF AND TO THE EXCLUSION OF ALL OTHER WARRANTIES, EXPRESS, IMPLIED, OR STATUTORY, INCLUDING ANY IMPLIED WARRANTY OF MERCHANTABILITY OR FITNESS FOR A PARTICULAR PURPOSE. IN NO EVENT SHALL INNOVATION CABINETRY, LLC'S LIABILITY EXCEEDS THE BUYER'S PURCHASE PRICE. THE LIMITED WARRANTY RUNS ONLY TO THE ORIGINAL END-USER OF THE PRODUCTS. THE LIMITED WARRANTY IS NOT INTENDED TO, AND DOES NOT, RUN TO ANY SUBSEQUENT BUYER OR END-USER, NOR TRANSFERRED TO ANY OTHER PERSON, UNLESS OTHERWISE SPECIFICALLY STATED IN WRITING BY AN OFFICER OF INNOVATION CABINETRY, LLC. IN NO EVENT SHALL INNOVATION CABINETRY, LLC BE LIABLE TO THE END-USER OR ANY THIRD PARTY FOR SPECIAL, COLLATERAL, INCIDENTAL, CONSEQUENTIAL OR PUNITIVE DAMAGES.

This Warranty gives you specific legal rights, and you may have other rights, which vary from state to state. Some states do not exclude or limit incidental or consequential damages, so the above limitations or exclusions may not apply.

SUBMITTING A CLAIM

- Provide the original dated sales receipt with the names and sizes of the products claimed as proof of purchase from an Innovation Cabinetry Dealer.
- Include photographs from multiple angles and close-ups of the damage/s with an explanation of the claim, including sizes and type of the products.
- Submit the claim with attachments to customerservice@innovationcabinetry.com or Innovation Cabinetry, 7030 Anderson Road; Tampa, FL 33617.
- Replacement of affected cabinet, parts, or components is at the sole discretion of Innovation Cabinetry, LLC.



CUSTOMER CARE

FOR THE HOMEOWNER InnovationCabinetry.com

Our website offers many ways to inspire you to live outdoors with solutions in beautiful outdoor cabinetry. Highlights include:

- View inspirational designs and photos
- Visual details of door by style
- Consumer education about cabinetry care and our lifetime warranty

FOR DESIGNERS AND DEALERS InnovationCabinetry.com

If you're not currently registered for InnovationCabinetry.com, you could be missing important product and brand information. It's quick and easy, so visit the site and register today. It will enable you to:

- Place an Ready-to-Assemble (RTA) order or download the Endura order form 24-7
- Download or order product literature, like the product brochure, specification, and price books
- Access state-of-the-art design resources; 2020 Design and SketchUp libraries
- Order color swatches and door samples, and more from the shopping cart or Endura order form

CUSTOMER CARE RESOURCES

Electronic means are convenient, but sometimes you need to talk to someone.

At Innovation Cabinetry, every account may be assigned a Sales Account Manager who is there to help. Your Sales Account Manager can:

- Place an order
- Follow up on orders or track delivery progress
- Discuss product situations or address invoice questions
- Assist with designs and quotes

Additional assistance is available through Customer Service:
Tampa: 888.206.1088
Dallas: 888.290.9770
Email: customerservice@innovationcabinetry.com

Your Innovation Cabinetry Sales Account Manager is there to help you every step of the way. Make sure to contact them whenever you have questions,

concerns, or need information.
WHAT YOU NEED TO KNOW

Endura pairs quality USA craftsmanship with cutting-edge innovation. Constructed in HDPE, this outdoor kitchen collection offers elegance with casual sophistication.

Careful detailing has gone into the design and execution of each piece, from the well-crafted door embossing and edging to the innovative, patented hidden joinery technology for solid joints. The innovative materials, advanced manufacturing, and thoughtful design allow Endura to synthesize classic styling with a modern twist.



DURABLE CONSTRUCTION

The 0.75" marine-grade HDPE is UV and weather-resistant. Cabinets will never rot, delaminate, or splinter and never need refinishing.



INNOVATIVE TECHNOLOGY

Uniquely constructed with an hidden patented joinery technology for a beautiful finish with no visible fasteners.



MADE IN THE USA

Discover the excellence of American made outdoor cabinetry. Endura is manufactured and hand-assembled in Tampa, Florida with materials sourced from American companies.



LIMITED LIFETIME WARRANTY

Assures the cabinetry you are buying is of good quality and without manufacturing defects, for years of worry-free enjoyment.



EASY TO CLEAN

Easy-to-clean surfaces means you spend more time enjoying your cabinetry and less time cleaning them.



100% RECYCLABLE

HDPE has a recycling code of 2, which means at the end of its lifetime, it is easily recycled into usable products for home and garden.



We are a proud member of the National Kitchen & Bath Association (NKBA), a non-profit trade group that promotes professionalism in the kitchen and bath industry.

GET SOCIAL WITH US!

Follow Innovation Cabinetry on Facebook, Instagram and Pinterest for design inspiration and tips to make your space both functional and beautiful!



We love to see your projects. Tag us on Instagram @innovationcabinetry

SPECIAL NOTE: Throughout this brochure, the product names are intended to evoke the color and style of the material only and are not intended to indicate or describe the materials used in cabinetry manufacturing.

© 2023 Innovation Cabinetry LLC. All Rights Reserved. No image or information published in this publication may be reproduced, transmitted or copied (other than for the purposes of fair dealing, as defined in the Copyright Act 1968) without the express written permission of Innovation Cabinetry, LLC.





INNOVATION CABINETRY HEADQUARTERS - TAMPA

7030 Anderson Road | Tampa, Florida 33634

727-535-7667 | 888-206-1088 | fax 813-884-0007 | info@innovationcabinetry.com

INNOVATION CABINETRY - DALLAS

11925 N Stemmons FWY, Ste 190 | Dallas, Texas 75234

214-380-3660 | 888-290-9770 | fax 214-380-3661 | dallas@innovationcabinetry.com

Endura is manufactured for Innovation Cabinetry by Simmetry Manufacturing; Tampa, Florida.

GET SOCIAL WITH US:

